

PLAN

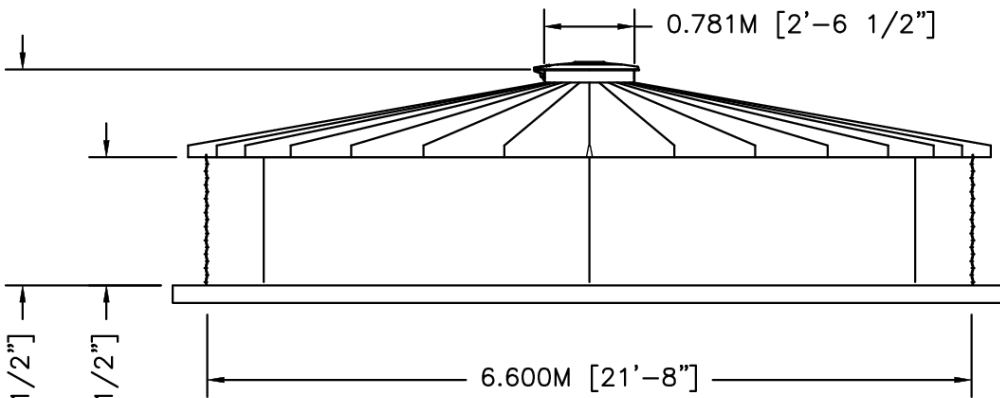

ELEVATION



	BY	DATE	TITLE	
DWN	XXX	XX/XX/XX	WTU07-01 30"PR 10DEG V-RIB	
CKD			NOMINAL CAPACITY - 33.459 M3 [8,839 GAL]	
ENG			DWG. NO. SCT2101-LVR WTU07-01	REV. NO.
SIZE: A		SCALE: 3/16"=1'-0"		SHEET 1 OF 1